

# **Blinds** *by* **Post**

## **Cruze Motorised Blinds Installation & Operation Instructions**

# ATTENTION! (1/2)

---

## 1. PRIOR INFORMATION

### 1.1 Sphere Of Application

32mm and 40mm Roller Motors are designed to drive all types of roller blinds. The installer, a home motorisation or home automation professional, must ensure that once the driven product is installed, it respects the current standards in the country of installation, notably standard EN 13120 relative to interior blinds.

### 1.2 Liability

Before installing and using the drive, please read these instructions carefully. In addition to the instructions provided in this guide, please also comply with the instructions set out in the enclosed Safety instructions document. The drive must be installed by a home motorisation and automation professional, in accordance with Cruze's instructions and the applicable regulations in the country of installation.

Any operation of the drive outside the sphere of application described above is prohibited. Such operation shall exclude Cruze from all liability and invalidate the Cruze warranty, as will any failure to comply with the instructions given herein and in the enclosed Safety instructions document.

After installing the drive, the installer must inform his customers of the operating and maintenance conditions for the drive and must pass the operating and maintenance instructions on to them, as well as the enclosed Safety instructions document. Any After-Sales Service operation on the drive requires intervention by a home motorisation and automation professional.

Should any doubt arise during installation of the drive or for additional information, consult a Cruze contact or visit [www.cruzehome.co.uk](http://www.cruzehome.co.uk)

## Attention





---



- These instructions are mandatory for the home motorisation and automation professional installing the drive.
- Never drop, knock or puncture the drive or immerse it in liquid.
- Install an individual control point for each drive.

## GENERAL INFORMATION

Safety instructions

-  **Danger**  
Indicates a danger which may result in immediate death or serious injury.
-  **Warning**  
Indicates a danger which may result in death or serious injury.
-  **Precaution**  
Indicates a danger which may result in minor or moderate injury.
-  **Attention**  
Indicates a danger which may result in damage to or destruction of the product.

## ATTENTION! (2/2)

---

In order to protect your blind during transit, the motor has been placed in sleep mode, prior to installation please wake the motor up by following the below instruction;

**Press the programming button on the motor head for 1 second the blind will jog once confirming it is now awake.**

Charge the battery by connecting the charger to the motor. Charging will take up to 5 hours.

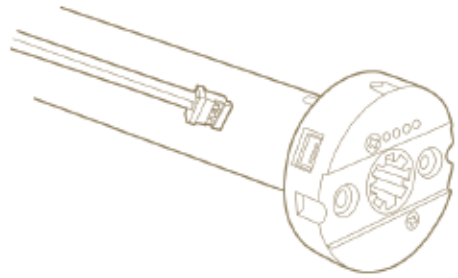

|  | LED Illuminates                             | Behaviour                   |
|---|---|-----------------------------|
|   | Solid <b>Red</b> LED                        | Charging                    |
|   | <b>Green</b> LED blinks twice every 10 secs | Charging is near completion |
|   | Solid <b>Green</b> LED                      | Charging is complete        |

Ensure the battery is fully charged prior to installation of the blinds on-site.

 **Wiring Precaution**  
To ensure electrical safety the motor must be powered by a SELV, voltage source (Safety Extra Low Voltage)

 **Attention**  
Use only the power charge model DS090 130065B-3 supplied to charge the battery pack.

# FITTING INSTRUCTIONS (1/2)

You should have:

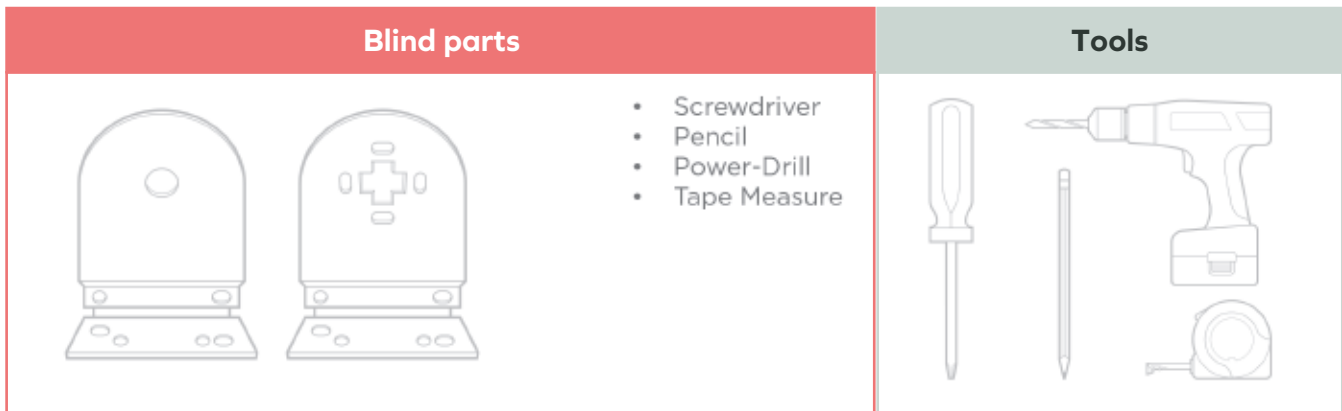

## STEP 1

The installation of this product should be conducted by someone competent in DIY

### Outside Recess

If the blind is to be fitted outside the window ensure that measurement C is the same. Follow instructions for FACE FIXING. To calculate C  $(A-B)/2$ .

### Inside Recess

TOP FIX to the lintel. FACE FIX bracket to the window frame.

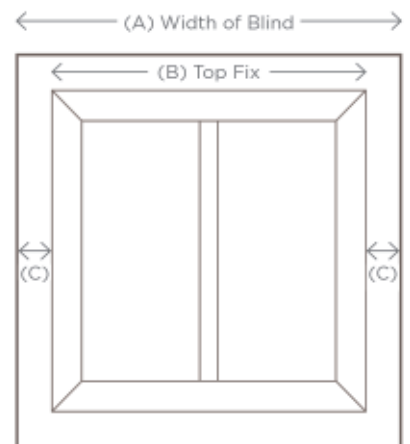

## STEP 2

### Top Fixing

Measure and mark the distance (D), allowing for obstructions like handles that protrude into the recess area. Hold each bracket into place and mark the hole positions. Fit each bracket using suitable screws. Please ensure fixings are suitable for the wall/surface to which you are mounting the brackets.

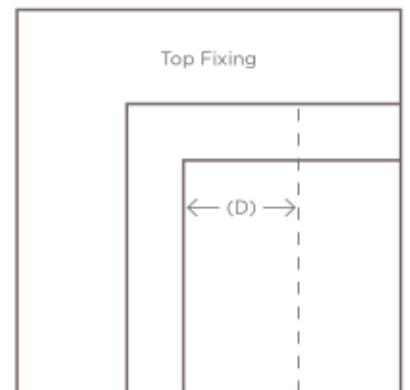

# FITTING INSTRUCTIONS 2/2

---

## Face Fixing

Hold each bracket into place and mark the hole positions. Fit each bracket using suitable screws. Please ensure fixings are suitable for the wall/surface to which you are mounting the brackets.

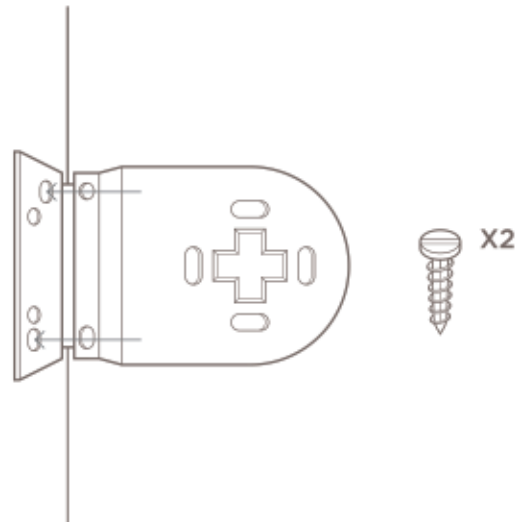

## STEP 3

Holding the fully-wound blind, insert the idle pin end into the bracket as shown.

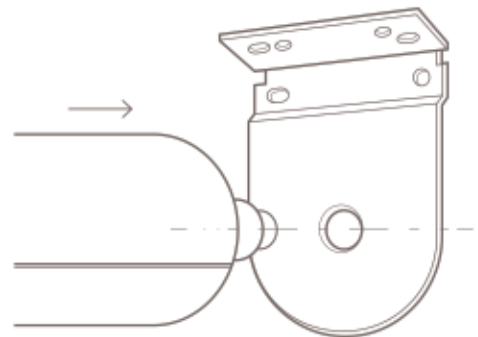

With the Idle pin end in place. Insert the control end into the opposite bracket by depressing the pin end then pull down vertically until the control end clicks into position.

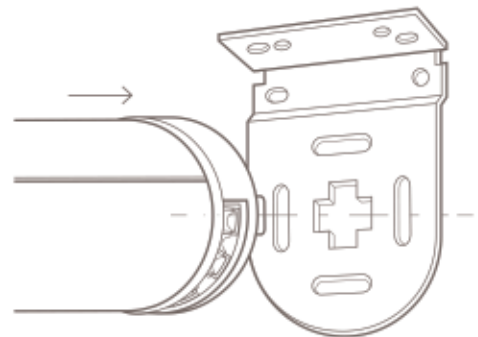

## STEP 4

### Fabric Run-Off

Diagram 1 shows the fabric running off from the right-hand side of the blind. To correct the run-off, unroll the fabric, place a 25mm piece of sticky tape onto the tube (Diagram 2) at the opposite end of the blind to the run-off. Fully wind the blind up. Repeat until the fabric is no longer running-off.

DIAGRAM 1

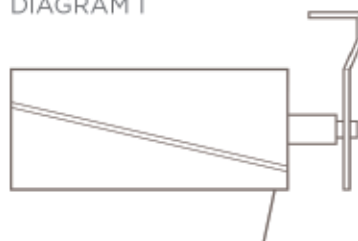
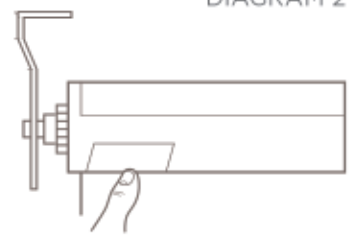

DIAGRAM 2



# OPERATING YOUR CRUZE REMOTE

## 4 CHANNEL RTS REMOTE



FRONT

BACK



← PROGRAMMING BUTTON

# OPERATING INSTRUCTIONS

---

**Note:** In order to protect your blind during transit, the motor will be placed in sleep mode, prior to installation you will need to wake the motor up.

## WAKING THE MOTOR UP

Press and hold the programming button on the motor head for 1 second, the blind will jog once. The motor programming button will look different depending on model you have opted for..

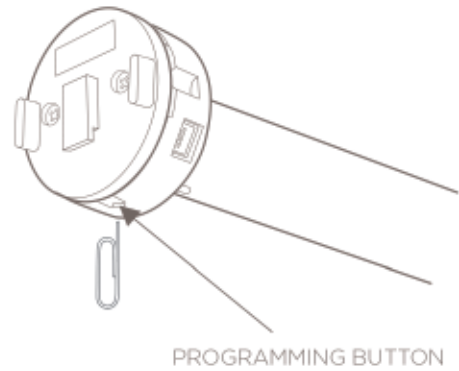

## OPERATING THE BLIND

**Note:** The remote and blind should arrive paired and the lower and upper limits on the blind will be pre-set. You can operate the blind immediately, or if you wish to adjust the limits please follow the limits adjusting instructions in the programming section.

1. To change channel press the **CHANNEL SELECTOR** to select the desired channel.  
  
(Channel indicator will briefly be lit).

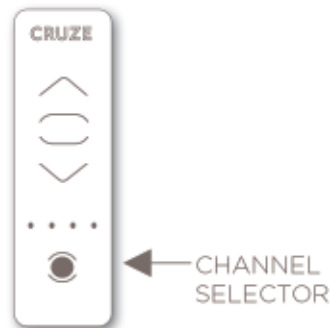

2. Briefly press the **UP** button to move to the upper limit.



3. Briefly press the **DOWN** button to move to the lower limit.



4. Briefly press the **STOP** button to move to the intermediate limit (favourite position).

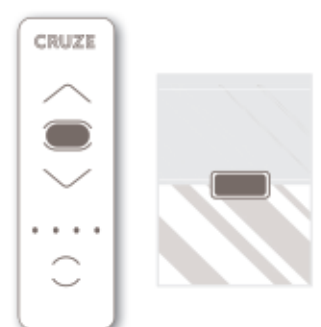

# PROGRAMMING INSTRUCTIONS (1/6)

---

To programme blinds individually, wake the individual motor up and programme one motor at a time. If programming more than one motor on a multi channel remote, ensure all other motors are in sleep mode whilst programming individual motors.

## ACTIVATING TEMPORARY SLEEP MODE

**Note: Temporary sleep mode lasts 15 minutes.**

Press and hold the programming button on the motor head and the blind will jog once, next briefly press the programming button again and the motor will jog twice. The LED will flash orange while the motor is in temporary sleep mode.

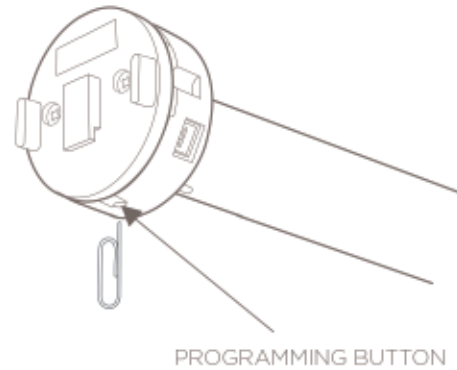

## ACTIVATING LONG TERM SLEEP MODE

Hold the programming button on the motor head, the motor will jog once. On the remote hold the **UP**, **DOWN** and **STOP** buttons simultaneously until the blind jogs twice.

## DEACTIVATING SLEEP MODE

Press and hold the programming button on the motor head for 1 second, the blind will jog once.

## CHECKING THE REMOTE IS PAIRED WITH THE MOTOR

Press the **UP** or **DOWN** button on the remote, if the blind moves the remote is paired. If the blind does not move, follow the pairing a remote instruction.





# PROGRAMMING INSTRUCTIONS (2/6)

---

If the motor does not respond to the remote, the motor will need to be reconnected. To do this make sure the motor is awake, hold the programme button on the motor head for 2 jogs, next press the programming button on the back of the remote. The remote should now be connected and you can proceed to programming the motor.

## PAIRING THE FIRST REMOTE

1. Using the **CHANNEL SELECTOR**, select the desired channel (channel indicator will briefly be lit).

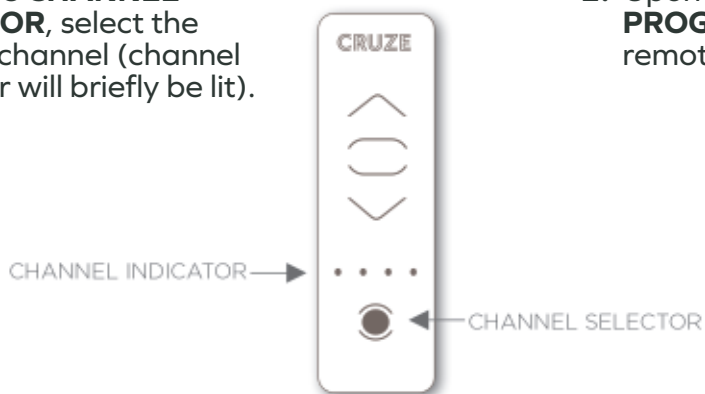

2. Upon waking the motor, press **PROGRAM** button on the remote until the blind jogs

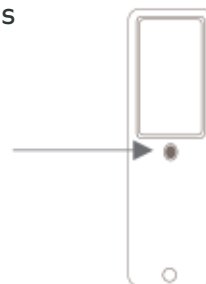

---

## PAIRING A SECOND REMOTE

**Note: When pairing a remote, ensure you have selected the correct channel in which you wish to operate the blind on.**

1. Using a paperclip or pen, press and hold the **PROGRAM** button on the original remote until the blind jogs once.

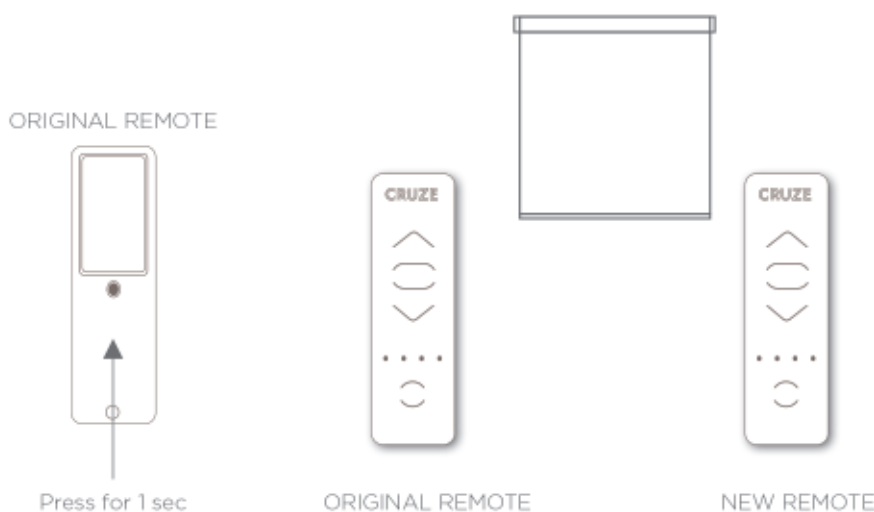

2. Using a paperclip or pen, press the **PROGRAM** button on the new remote until the blind jogs once. New remote is now added to the memory and can be used to operate the blind.

# PROGRAMMING INSTRUCTIONS (3/6)

---

## ADDING A CHANNEL

1. Select the desired channel you wish to duplicate by momentarily pressing the **CHANNEL SELECTOR** button on the multichannel remote.

2. Using a paperclip or pen, press and hold the **PROGRAM** button on the remote until the blind jogs once.

3. Ensuring you are on the new channel press the **PROGRAM** button on the remote until the blind jogs once. Additional (new) channel is now added to the motor memory and can be used to operate the blind.

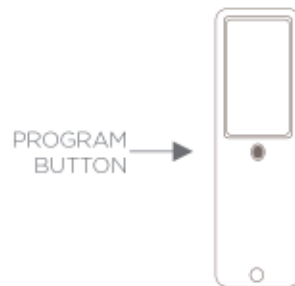
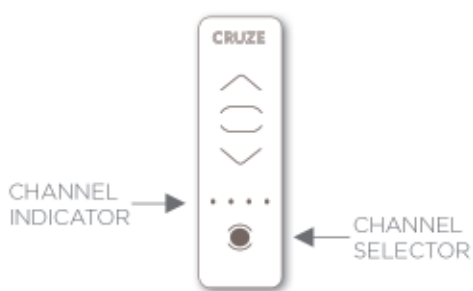

## DELETING A CHANNEL

1. Using a paperclip or pen, press and hold the **PROGRAM** button on the remote until the blind jogs once.

2. On the remote select the desired channel to be deleted.

3. press the **PROGRAM** button on the remote until the blind jogs once. Channel is now deleted from the motor memory and will not operate the blind.

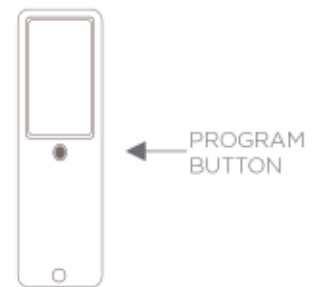
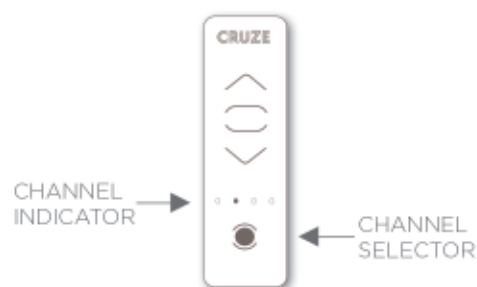
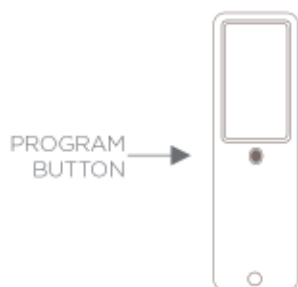

# PROGRAMMING INSTRUCTIONS (4/6)

---

## ADJUSTING THE MOTOR ROTATION DIRECTION

1. Press the **UP** or **DOWN** on the remote to move the blind away from the end limits.
2. Press and hold the **UP** and **DOWN** buttons simultaneously until the blind jogs.
3. Press the and hold **STOP** button until the blind jogs, the rotation direction is now reversed.
4. Press the **UP** button to check the new rotation direction.



## ADJUSTING UPPER LIMIT

**Note:** Blind limits will be pre-set on arrival

1. Briefly press the **UP** button. Blind will move to pre-set upper limit.
2. Press and hold the **UP** and **DOWN** button until the blind jogs.
3. Press and hold the **UP** or **DOWN** button to move the blind to the new upper position.
4. To confirm the new position press and hold the **STOP** until the blind jogs. The new upper limit is now added to the memory.



# PROGRAMMING INSTRUCTIONS (5/6)

## ADJUSTING LOWER LIMIT

Before operating the remote, ensure the correct channel is selected.

1. Briefly press the **DOWN** button. Blind will move to pre-set upper limit
2. Press and hold the **UP** and **DOWN** button until the blind jogs.
3. Press and hold the **UP** or **DOWN** button to move the blind to the new lower position.
4. To confirm the new position press and hold the **STOP** until the blind jogs. The new lower limit is now added to the memory.



## SETTING INTERMEDIATE LIMIT (FAVOURITE POSITION)

Note: The intermediate limit is optional and has not been pre-set

1. Move the blind to the desired intermediate limit using the **UP** or **DOWN** buttons.
2. Briefly press the **STOP** button to stop at the desired position.
3. Press and hold the **STOP** button until the blind jogs, the intermediate limit is now memorised, and the green LED light will flash 5 times.



## SPEED ADJUSTMENT MODE

1. Press the **UP** or **DOWN** button on the remote to move the blind away from the end limits.
2. Press and hold the **UP**, **STOP** and **DOWN** buttons simultaneously until the blind jogs once.
3. The blind will jog in 10 second cycles until it enters into speed adjustment mode.



# PROGRAMMING INSTRUCTIONS (6/6)

**Note:** To increase or decrease the motor speed, you must first enter speed adjustment mode.

## INCREASING THE MOTOR SPEED

Press and hold the **UP** button until the blind jogs, repeat as needed. The maximum setting has been reached when the blind briefly moves 3 times in one direction and three times in the opposite direction.



## DECREASING THE MOTOR SPEED

Press and hold the **DOWN** button until the blind jogs, repeat as needed. The minimum setting has been reached when the blind briefly moves 3 times in one direction and three times in the opposite direction.



## CONFIRMING NEW SPEED SETTINGS

Press and hold the **STOP** button until the blind briefly jogs.



## RESTORE TO FACTORY SETTINGS

**\*\*\* WARNING! - All remotes and limits will be erased from the motor memory \*\*\***

To delete all previous settings: Using a paperclip, press and hold the PROGRAM button, located on the top of the motor casing, until the blind jogs 3 times (approx. 12 seconds).

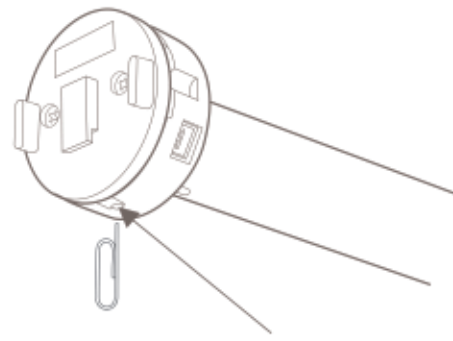

PROGRAMMING BUTTON

## CORRECTING FABRIC RUN-OFF

Diagram 1 shows the fabric running off from the right-hand side of the blind. To correct the run-off, unroll the fabric, place a 25mm piece of sticky tape onto the tube (Diagram 2) at the opposite end of the blind to the run-off. Fully wind the blind up. Repeat until the fabric is no longer running-off.

DIAGRAM 1

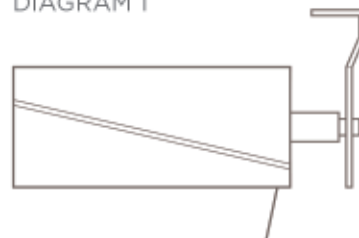
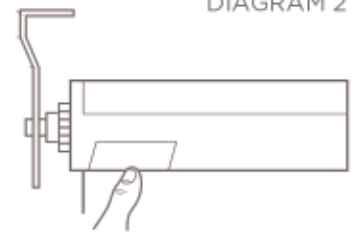

DIAGRAM 2



# ATTENTION!

---

# CRUZE



Decora Blind Systems Ltd Lisburn-BT28 2FL as manufacturer hereby declares that the drive covered by these instructions and used as intended according to these instructions is in compliance with the essential requirements of the applicable European Directives and in particular of the Machinery Directive 2006/42/EC, and the Radio Directive 2014/53/EU.



The full text of the EU declaration of conformity is available at [www.cruzehome.co.uk/standards](http://www.cruzehome.co.uk/standards)



Please separate storage cells and batteries from other types of waste and recycle them via your local collection facility



We care about our environment. Do not dispose of the appliance with usual household waste. Give it to an approved collection point for recycling.