

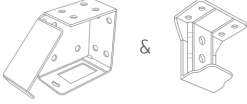







Blinds *by* **Post**

Sunwood Venetian Blinds Installation & Operation Instructions

FITTING INSTRUCTIONS 1/4

You should have:

| Blind parts | | | | Tools | |
|--|--|--|--|---|---|
| Brackets  | Safety device  | Wood screw for bracket - (2 per bracket) 2 screws per valance clip/ return clip, 2 screws for safety cleat. 4 screws for hold down bracket  | Valance clip & return clip  | Screw driver  | Drill  |
| | | | Hold down brackets  | Tape measure  | Pencil  |

STEP 1

The installation of this product should be conducted by someone competent in DIY.

Outside Recess

If the blind is to be fitted outside the window ensure that measurement C is the same. Follow instructions for FACE FIXING. To calculate $C=(A-B)/2$.

Inside Recess

TOP FIX to the lintel or FACE FIX brackets to the window frame.

Children can strangle if a safety device is not installed. Always use a safety device to keep cords and chains out of reach of children.

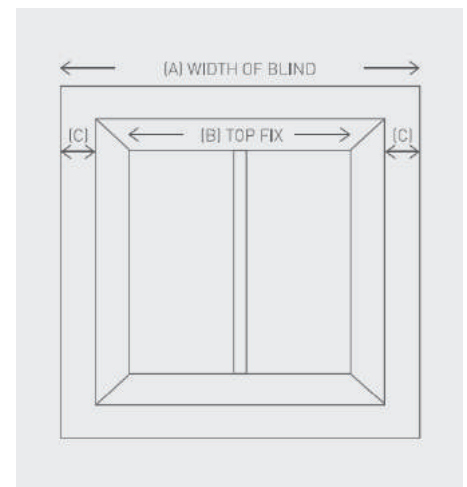

STEP 2

The installation height of this blind must not be less than 1500mm from the floor.

Top Fixing

Measure and mark the distance between the wall and the back of the bracket, allowing for obstructions like handles that protrude into the recess area. The brackets should be positioned 6mm wider than the blind at each end. Hold each bracket into place and mark the hole positions. Fit each bracket using the screws provided. Please ensure fixings are suitable for the wall/surface to which you are mounting the brackets.

Face Fixing

The brackets should be positioned 6mm wider than the blind at each end. Hold each bracket into place and mark the hole positions. Fit each bracket using the screws provided. Please ensure fixings are suitable for the wall/surface to which you are mounting the brackets.

Side Fixing

Hold each bracket into place and mark the hole positions. Fit each bracket using the screws provided. Please ensure fixings are suitable for the wall/surface to which you are mounting the brackets.

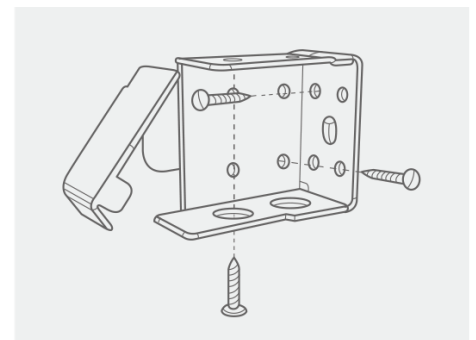

FITTING INSTRUCTIONS 2/4

STEP 3

Support Bracket

For larger width blinds a support bracket is required. Align the top of the support bracket with the top of the mounting bracket before installation. Install with the bigger flap of the support bracket on the top equally spaced along the width and clear of the slat ladder positions.

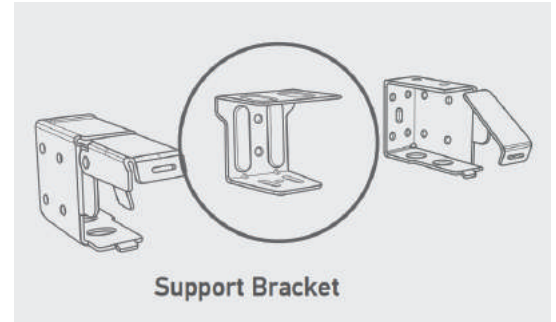

Open the gate of the box brackets and slide the headrail into position then snap the brackets closed.



| Number of ladders | End fix brackets | Support brackets (supplied) |
|-------------------|------------------|-----------------------------|
| 2 | 2 | 0 |
| 3 | 2 | 1 |
| 4 | 2 | 2 |
| 5 | 2 | 3 |

Hold Down Bracket (Optional)

Hold down brackets: Using two small screws, screw hold down bracket to window facing or wall. Snap bracket pin ends into the hole at bottom rail end.

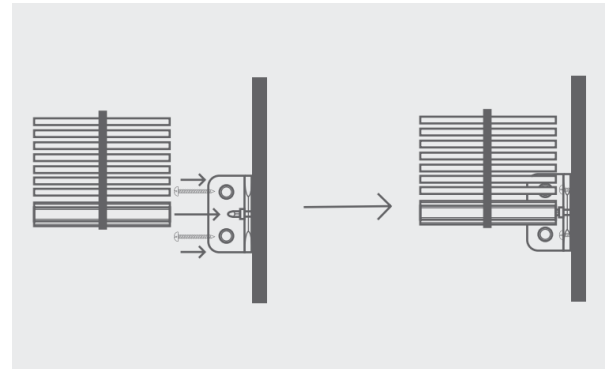

STEP 4

Attaching The Valance

Dual Lock

Remove the plastic from the dual lock positioned on the headrail. Place the valance in the required position and firmly press the valance against the dual lock for 5 seconds to secure the valance.

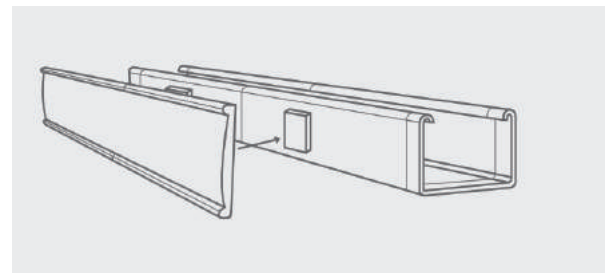

FITTING INSTRUCTIONS 3/4

Valance Clip (Optional)

Screw valance clips onto the back and level with the top of the valance using the screws provided.

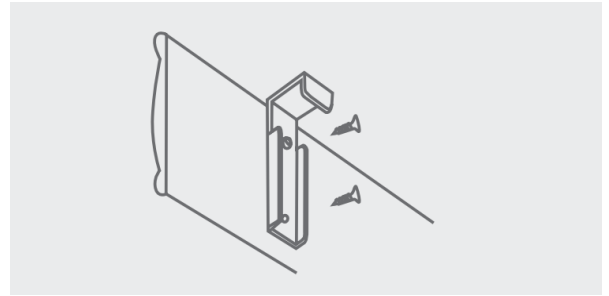

Hook valance clip with valance attached onto the top of the headrail.

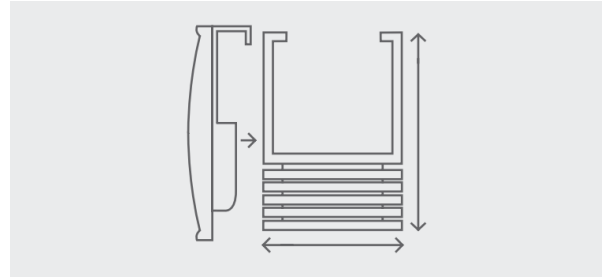

Valance Returns (Optional)

If your blind has been supplied with valance returns screw one end of the valance return clip onto the valance using screws provided. Align the edge of the valance return with the valance. Screw the other end of the valance clip onto the valance return.

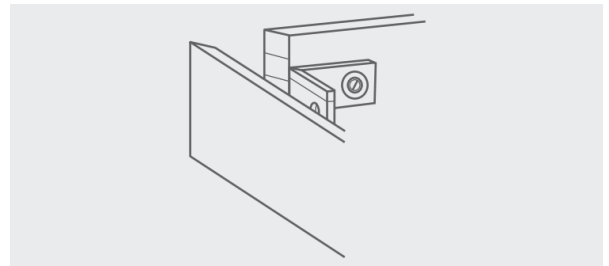

STEP 5

Safety Device

Cord safety cleat - The safety cleat shall be installed as close to the headrail as possible and in all cases not less than 1500mm from the floor.

The Cord must be fully accumulated around the safety cleat(s) when the blind is not in use.

Use the table below to determine the distance required between the cleats to fully accumulate the cords when the blind is fully raised.

| Drop of Blind | *Distance between cord cleats (centre to centre) |
|---------------|--|
| 1-1000mm | 100mm |
| 1001-2000mm | 150mm |
| 2001-3000mm | 300mm |

Place the safety cleat in the desired position on the wall and mark the positions of the holes with a pencil. (Note: Based on cord up to 2.8mm, 17m can be accumulated in total.)

Mark the hole positions and drill as required.

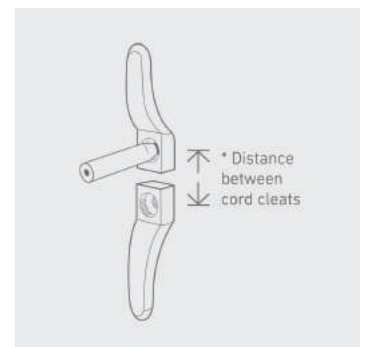

FITTING INSTRUCTIONS 4/4

Use the screws provided to attach the safety cleat to the wall.

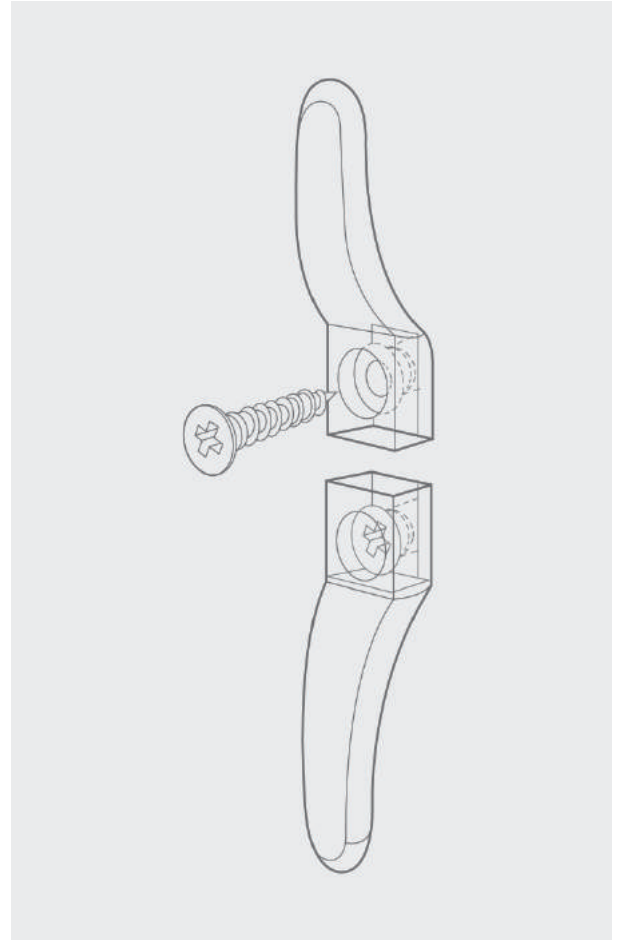

Wrap the cords around the cord cleats in a figure of 8.

When the cords are fully accumulated ensure they are secure so when any cord is pulled no excess cord is released.

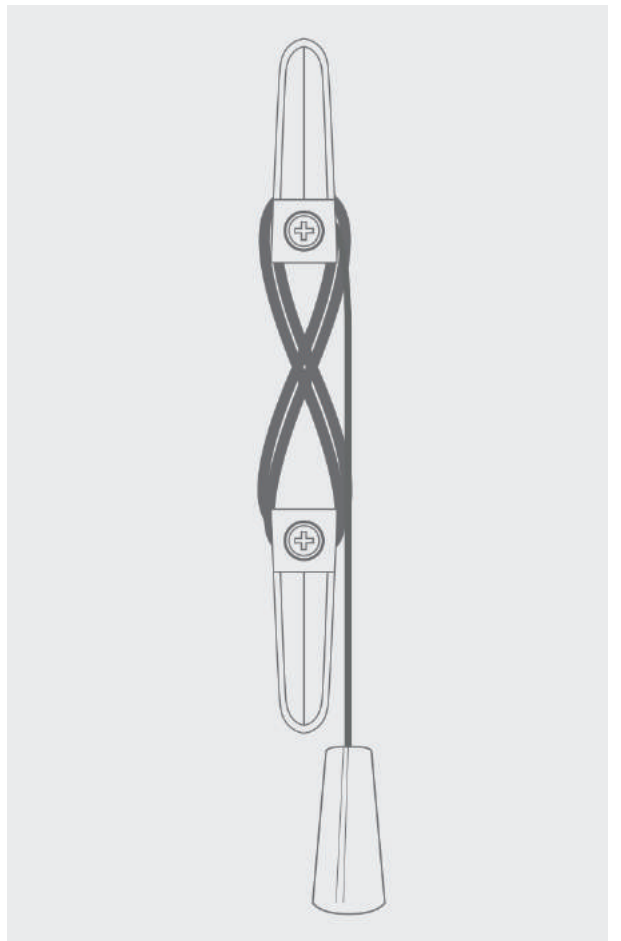

OPERATION INSTRUCTIONS

PLEASE READ THE INSTRUCTIONS BEFORE OPERATING THIS PRODUCT

To tilt blind: Pull on required tilt cord tassel to tilt slats to the open/closed position.

Tilt blind horizontal before raising/lowering to extend the life of the blind.

To lower blind: Move lift cord towards middle of the blind pulling down gently until cord lock releases.

To raise blind: Pull lift cord downward until blind reaches desired height.

To lock cords: Pull lift cord towards the outside of the blind and release. Cord will lock automatically.

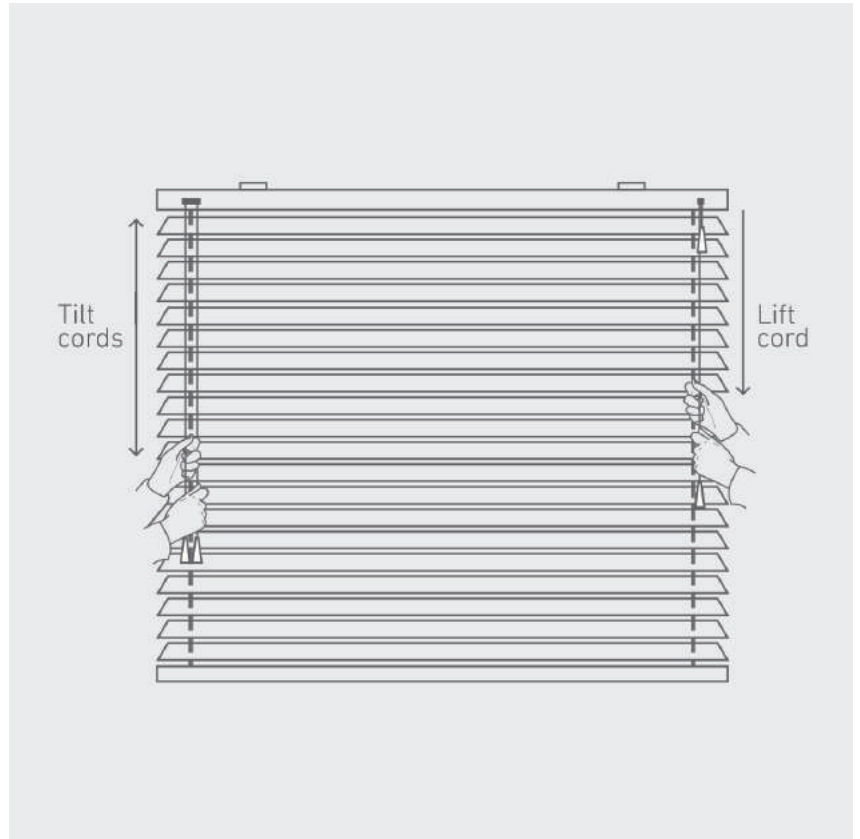

MAINTENANCE

The product is maintenance free however we recommend that regular visual checks are completed to ensure that no components have been damaged, which could result in operating difficulties and/or cause a safety risk. If any maintenance is required we recommend that the work is carried out immediately, by a reputable blind company.

Young children can be strangled by loops in pull cords, chains, tapes and inner cords that operate the product.

To avoid strangulation and entanglement, keep cords out of the reach of young children. Cords may become wrapped around a child's neck. Move beds, cots and furniture away from window covering cords.

Do not tie cords together. Make sure cords do not twist and create a loop.

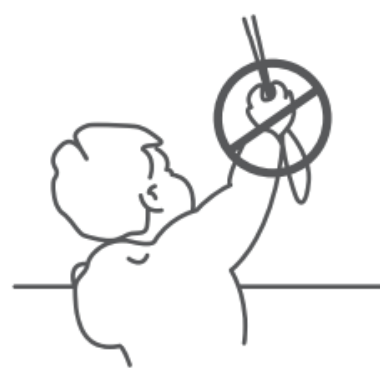

make it safe



BREAKAWAY CORD CONDENSER (OPTIONAL)

Breakaway cord condenser is pre-fitted to the lift cords so that when a horizontal force is applied to the cords entering the condenser it safely breaks away eliminating any hazardous loops.

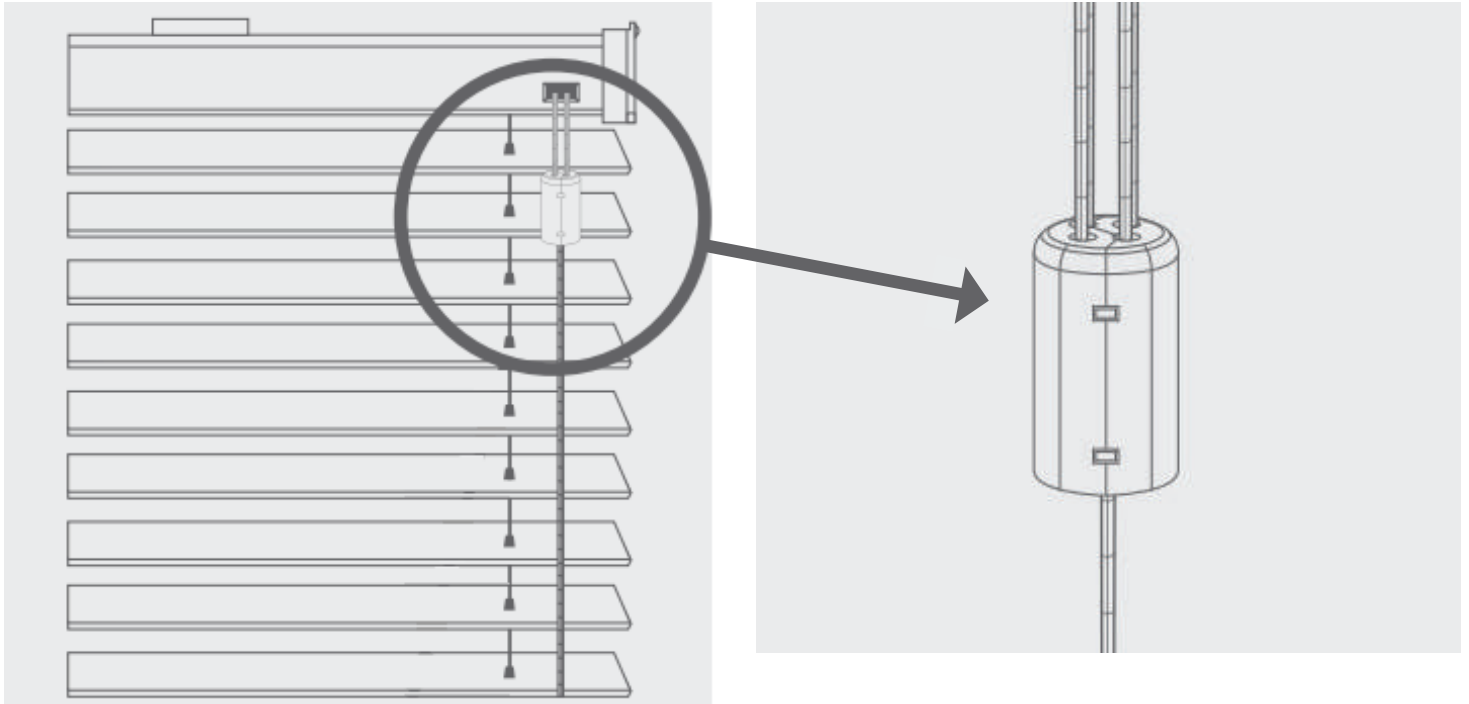

If the cord condenser is pulled apart:

Untangle and untwist cords.

For 2 cords: Press the cord condenser together until it is fully closed.

For 3 cords: Place the loose cord in the opening in one half of the cord condenser and press the cord condenser together until it is fully closed.

If there are any doubts that the cord condenser has not been re-attached correctly it can be tested by placing your arm between the cords and pressing downwards. The condenser should break apart with minimal force, if it does not breakaway tie cords out of reach of children and contact a reputable blind company to repair the blind.

